

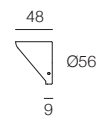













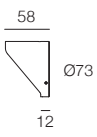

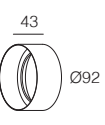

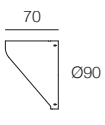

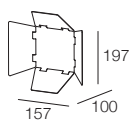

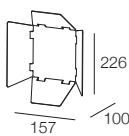

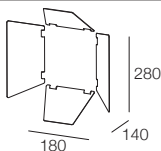
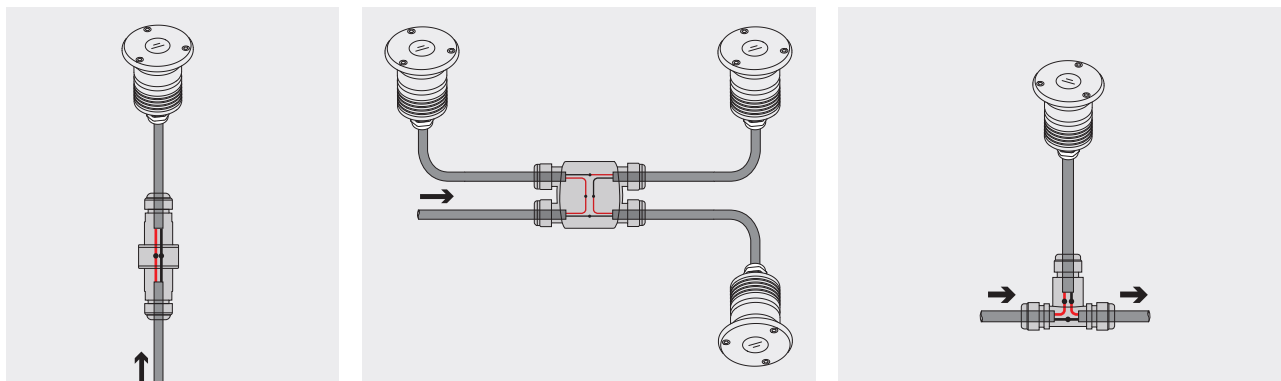

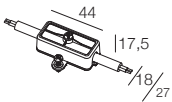

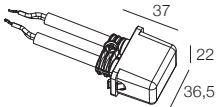

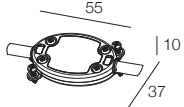

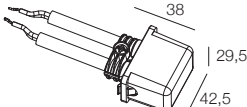
		CODE	DESCRIPTION	USE WITH	
		A00519.30 Grigio - Gray	Visiera antiabbagliamento Low glare visor	MACRO IP67	
		A00519.40 Nero - Black		ODINO 6 P	
		A00519.B0 Bronzo Scuro - Dark Bronze		MACRO H350 / H500	
		A00848.30 Grigio - Gray	Visiera cilindrica antiabbagliamento Low glare snoot		
		A00848.40 Nero - Black			
		A00848.T0 Titanio - Titanium			
		A00519.60	Visiera antiabbagliamento Acciaio inox 316L Low glare visor Stainless Steel 316L	MACRO IP68	
		A00848.60	Visiera cilindrica antiabbagliamento Low glare tube visor		
		A00936.30 Grigio - Gray	Visiera antiabbagliamento Low glare visor	ODINO 15 P	
		A00936.40 Nero - Black			
		A00936.B0 Bronzo Scuro - Dark Bronze			
		A00960.40 Nero - Black	Visiera cilindrica antiabbagliamento Low glare snoot	TULI IP67	
		A00420.30 Grigio - Gray	Visiera antiabbagliamento Low glare visor	QUANTUM P	
		A00420.40 Nero - Black			
		A00420.T0 Titanio - Titanium			
		A00512.40	Visiera orientabile Adjustable barn doors	PEGASO 3 IP67	
		A00513.40	Visiera orientabile Adjustable barn doors	PEGASO 4 IP67	
		A00514.40	Visiera orientabile Adjustable barn doors	PEGASO 7 IP67	

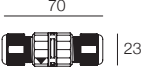
Connettori stagni IP68

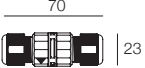
Watertight connectors IP68

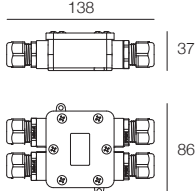

	CODE	MATERIAL	DESCRIPTION
 	A00357.40	Plastico Plastic	Micro connettore stagno Micro watertight connector IP68 - CABLE Ø4,8 mm ÷ Ø6 mm Section 2x0,75 mm
 	A00387.40	Plastico Plastic	Connettore stagno Watertight connector IP68 - CABLE Ø6 mm ÷ Ø8 mm Section 2x1 mm
 	A01023.40	Plastico Plastic	Connettore stagno Watertight connector IP68 - CABLE Ø5 mm ÷ Ø7 mm Section 3x1 mm
 	A00388.40	Plastico Plastic	Connettore stagno Watertight connector IP68 - CABLE Ø6mm ÷ Ø8 mm Section 3x1,5 mm
 	A01090.40	Plastico Plastic	Mini connettore lineare IP68 2 poli 2 Poles mini linear connector IP68 Sezione del conduttore 0,25 mm ² - 2,5 mm ² Conductor cross section 0,25 mm ² - 2,5 mm ² Diametro esterno del cavo 7 mm - 12 mm Cable outer diameter 7 mm - 12 mm
 	A01091.40	Plastico Plastic	Mini connettore lineare IP68 2 poli 2 Poles mini linear connector IP68 Sezione del conduttore 0,25 mm ² - 2,5 mm ² Conductor cross section 0,25 mm ² - 2,5 mm ² Diametro esterno del cavo 5,5 mm - 7 mm Cable outer diameter 5,5 mm - 7mm
 	A01089.40	Plastico Plastic	Scatola di derivazione IP68 Junction box IP68
 	A00155.40	Plastico Plastic	Connettore "T" IP68 3 poli IP68 "T" connector 3 poles Sezione del conduttore 0,5 mm ² - 4,0 mm ² Conductor cross section 0,5 mm ² - 4,0 mm ² Diametro esterno del cavo 6,0 mm - 13,5 mm Cable outer diameter 6,0 mm - 13,5 mm

Fissaggi per lineari

fixing for linear systems

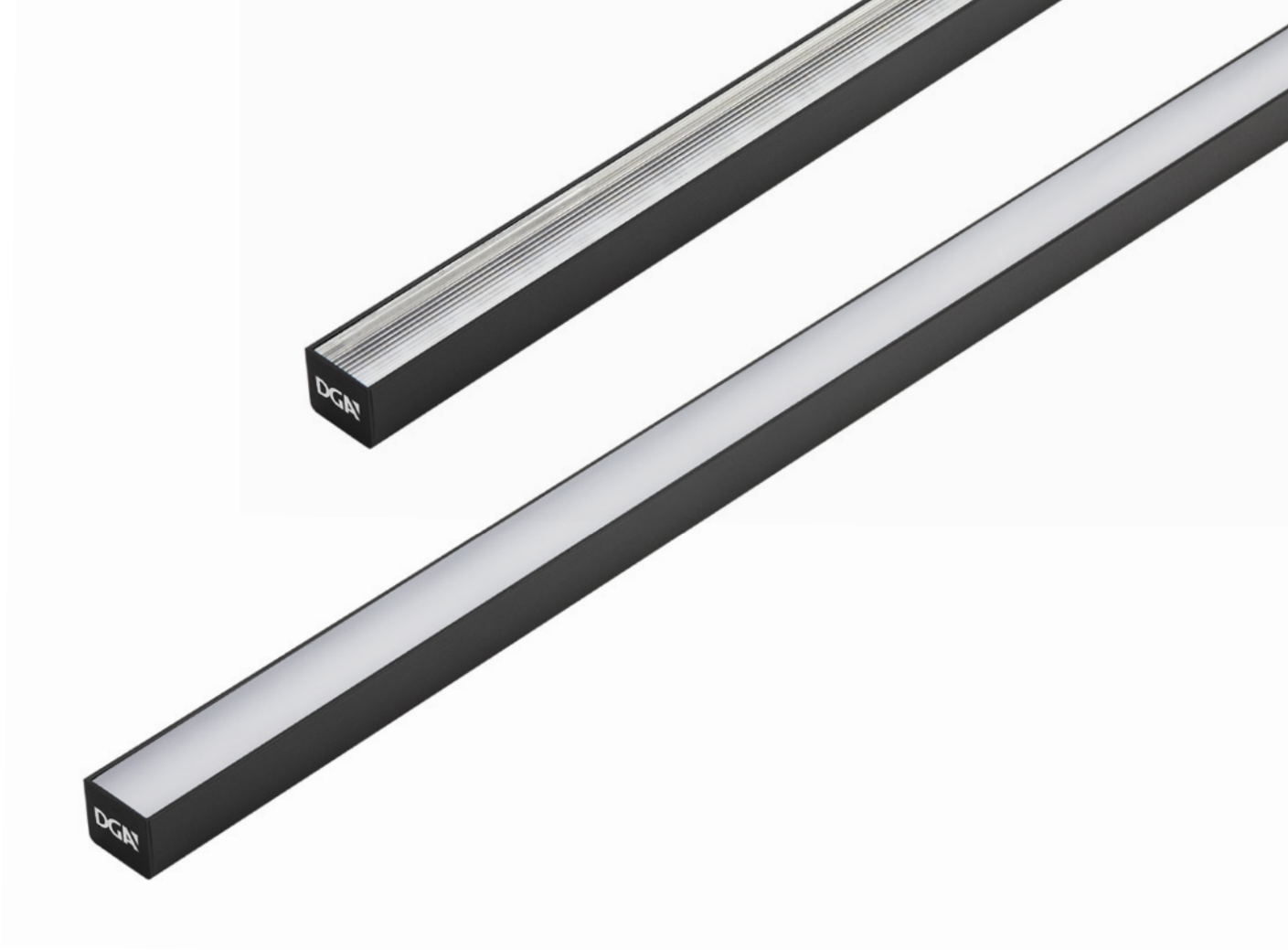

ARMONIA

SERIES

SISTEMI DI FISSAGGIO INTEGRATI

INTEGRATED FIXING
SYSTEMS

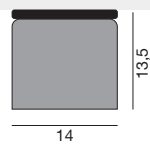

DESCRIPTION

NASTRO BIADERSIVO

Considerare una profondità di 13,5 mm
Prevedere una superficie perfettamente
asciutta e pulita per garantire il corretto
fissaggio del nastro biadesivo.

DOUBLE SIDED TAPE

Please consider 13,5 mm depth
Please provide a perfectly dry and clean
surface to grant the correct fastening of the
double sided tape.

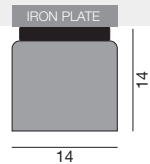

MAGNETI ESTERNI

Considerare una profondità di 14 mm
Prevedere una piastra di ferro per garantire
il corretto fissaggio dei magneti.

EXTERNAL MAGNETS

Please consider 14 mm depth
Please provide an iron plate to grant the
correct fastening of the magnets.