









MACRO IP67

















-  IP67
-  Class III
-  Montaggio a parete, soffitto, pavimento
Wall, ceiling, floor mounting
-  WIPS - Water Infiltration Protection System
-  Cavo in neoprene 200 cm
200 cm neoprene cable
(disponibile lunghezza cavo su misura)
(additional cable length available upon request)
-  Collegare in serie 500mA o 700mA o 900mA
Connect in series at 500mA or 700mA or 900mA
-  280 gr
-  Altamente riciclabile
Highly recyclable



Apparecchio mimetico e discreto
Optica confortevole
Puntamento preciso

Camouflage and discreet device
Comfortable optics
Precise pointing





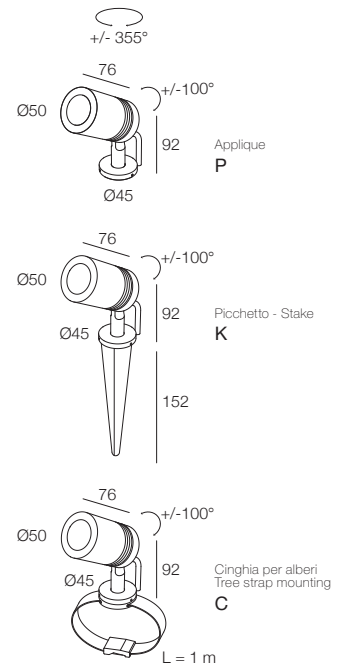











MACRO IP67

	3W 900mA	6W 500mA	9W 700mA	Finiture Finish	Colore LED LED Colour	Elementi di fissaggio Fixing element
Lumen Output 3000K	200lm	450lm	600lm			
 3° Lens	7T3694._._.			 3 Grigio - Gray	 Y 2700K	 P Applique - Applique
 10° Lens		733693._._.	733717._._.	 4 Nero - Black	 W 3000K CRI > 90	 K Picchetto - Stake
 30° Lens		763693._._.	763717._._.	 6 Acciaio Inox Stainless Steel AISI 316L	 6 3000K	 C Cinghia per alberi Tree strap mounting
 50° Lens		7D3693._._.	7D3717._._.	 T Titanio - Titanium	 J 3500K	
					 9 4000K	



MACRO IP67

CON NIDO D'APE - WITH HEX LOUVER

	3W 900mA	6W 500mA	9W 700mA	Finiture Finish	Colore LED LED Colour	Elementi di fissaggio Fixing element
Lumen Output 3000K	200lm	450lm	600lm			
 3° Lens	7T3696._._.			 3 Grigio - Gray	 Y 2700K	 P Applique - Applique
 10° Lens		733695._._.	733718._._.	 4 Nero - Black	 W 3000K CRI > 90	 K Picchetto - Stake
 30° Lens		763695._._.	763718._._.	 6 Acciaio Inox Stainless Steel AISI 316L	 6 3000K	 C Cinghia per alberi Tree strap mounting
 50° Lens		7D3695._._.	7D3718._._.	 T Titanio - Titanium	 J 3500K	
					 9 4000K	

ALIMENTATORI CONSIGLIATI (non inclusi)
SUGGESTED DRIVERS (not included)

500mA	CC20-F-500-N
700mA	CC20-F-700-N
900mA	CC20-F-900-N

ACCESSORI
ACCESSORIES



Visiera antiabbagliamento
Low glare visor
A00519._0



Visiera cilindrica antiabbagliamento
Low glare snoot
A00848._0



Connettore stagno
Watertight connector
A00387.40

EXAMPLE CODE COMPOSITION
123456.

