



Simboli Symbols	Prescrizioni	Prescriptions	Anforderungen	Prescriptions	Requisitos
	L'azienda declina ogni responsabilità qualora l'installazione non avvenga secondo le norme vigenti. Conservare copia del presente foglio di istruzioni	The company declines any responsibility for non-compliant installations with the current regulations. Keep a copy of this installation guide.	Der Hersteller trägt keine Verantwortung für eine Installation, die diesen Anforderungen und EU-Richtlinien nicht entsprechen. Eine Kopie dieser Montageanleitung halten.	Le fabricant décharge toute responsabilité pour installations non conformes aux normes en vigueur. Gardez toujours une copie de cette notice d'installation	La empresa declina toda responsabilidad si la instalación no se actúa de acuerdo con las normas vigentes. Guarde una copia de esta hoja de instrucciones de uso
	Il prodotto è conforme alla normativa RoHS che proibisce l'uso di apparecchi elettronici contenenti sostanze pericolose all'interno dell'Unione Europea	The product is RoHS compliant, which prohibits the use of electronic devices containing dangerous substances within the European Union	Das Produkt ist RoHS-konform und verbietet die Verwendung von elektronischen Geräten, die gefährliche Stoffe enthalten, innerhalb der Europäischen Union	Le produit est conforme RoHS, ce qui interdit l'utilisation d'appareils électroniques contenant des substances dangereuses dans l'Union européenne	El producto cumple con la norma RoHS, que prohíbe el uso de dispositivos electrónicos que contengan sustancias peligrosas dentro de la Unión Europea.



Manuale di installazione e uso





Installation and user manual - Notice d'installation et d'usage - Bedienungsanleitung - Manual de instalación y uso

1 SPECIFICHE

CHARACTERISTICS - CARACTÉRISTIQUES - MERKMALE - ESPECIFICACIONES TÉCNICAS

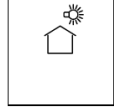
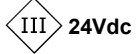
1.1 Caratteristiche funzionali

Functional characteristics - Caractéristiques fonctionnelles - Praktische Merkmale - Características funcionales



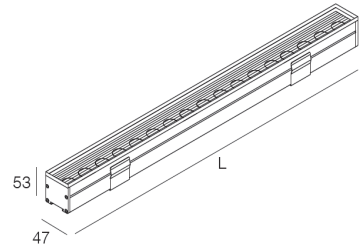

IP67	 2000 kg		 24Vdc	 T _a =+40°C	 - gr
			 240Vac		
Grado di protezione Protection rate	Carrabile Drive over	Adatto per uso in esterno Outdoor use	Protezione contro la scossa elettrica Protection against electric shock	Temperatura ambiente Ambient temperature	Peso Weigh
Degré de protection Schutzgrad	Carrossable Befahrbar	Pour usage extérieur Geeignet für den Außenbereich	Protection contre la décharge électrique Schutz gegen Stromschlag	Ambiente Temperatur der Umgebung	Poids Gewicht
Nivel de protección	Se puede pisar	Se puede usar en exteriores	Protección contra descargas eléctricas	Temperatura del entorno	Peso

1.2 Dimensioni

Dimensions - Dimensions - Maße - Dimensiones

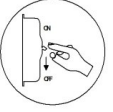
Codice prodotto Reference number	Alim. Supply	W Watt		Lunghezza (mm) Length (mm)	Dimensioni Dimensions
734462... 7G4462... 744462... 754462... 774462... 734463... 7G4463... 744463... 754463... 774463... 734464... 7G4464... 744464... 754464... 774464... 734465... 7G4465... 744465... 754465... 774465...	24 Vdc	9 W	10°	300	
25°					
40°					
60°					
EL					
10°					
25°		600			
40°					
60°					
EL					
10°			900		
25°					
40°					
60°					
EL					
10°		1200			
25°					
40°					
60°					
EL					
10°	11 W		300	25°	
40°					
60°					
EL					
10°		600			
25°					
40°					
60°					
EL					
10°			900		
25°					
40°					
60°					
EL					
10°	1200				
25°					
40°					
60°					
EL					
10°		21 W	300	25°	
40°					
60°					
EL					
10°	600				
25°					
40°					
60°					
EL					
10°			900		
25°					
40°					
60°					
EL					
10°	1200				
25°					
40°					
60°					
EL					
10°		11 W	300	25°	
40°					
60°					
EL					
10°	600				
25°					
40°					
60°					
EL					
10°			900		
25°					
40°					
60°					
EL					
10°	1200				
25°					
40°					
60°					
EL					
10°		21 W	300	25°	
40°					
60°					
EL					
10°	600				
25°					
40°					
60°					
EL					
10°			900		
25°					
40°					
60°					
EL					
10°	1200				
25°					
40°					
60°					
EL					
10°		11 W	300	25°	
40°					
60°					
EL					
10°	600				
25°					
40°					
60°					
EL					
10°			900		
25°					
40°					
60°					
EL					
10°	1200				
25°					
40°					
60°					
EL					

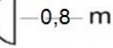
Simboli Symbols	Prescrizioni	Prescriptions	Anforderungen	Prescriptions	Requisitos
	L'azienda declina ogni responsabilità su installazioni non conformi alle norme vigenti e su montaggio e manutenzioni non rispettanti le presenti avvertenze e istruzioni d'uso	The company declines any responsibility for all installations not in compliance with the current regulations and for assembly/ maintenance procedures which do not follow the above warnings and instructions.	DGA lehnt jede Verantwortung ab für Installationen, die den aktuellen Richtlinien nicht entsprechen und für Montage- und Wartungsarbeiten, die die aufgelisteten Anwendungshinweise nicht einhalten.	Le fabricant décharge toute responsabilité des installations non conformes aux lois en vigueur et du montage/ maintenance qui ne respectent pas les susdites précautions et instructions d'utilisation.	La empresa declina toda responsabilidad por las instalaciones que no cumplan con las normas vigentes y por el ensamblaje y el mantenimiento que no cumplan advertencias e instrucciones de uso.
	Raccolta separata delle apparecchiature elettriche ed elettroniche. Il prodotto al termine della sua vita, deve essere conferito in un centro di raccolta differenziata per apparecchiature elettriche ed elettroniche oppure riconsegnato al rivenditore al momento dell'acquisto di una nuova apparecchiatura equivalente. L'utente è responsabile del conferimento dell'apparecchio a fine vita alle appropriate strutture di raccolta, pena le sanzioni previste dalla vigente legislazione sui rifiuti. L'adeguata raccolta differenziata per l'avvio successivo dell'apparecchio smesso al riciclaggio, al trattamento e allo smaltimento ambientalmente compatibile contribuisce ad evitare possibili effetti negativi sull'ambiente e sulla salute e favorisce il riciclo dei materiali di cui è composto il prodotto. Per informazioni più dettagliate inerenti i sistemi di raccolta disponibili, rivolgersi al servizio locale di smaltimento rifiuti o al negozio in cui è stato effettuato l'acquisto. I produttori e gli importatori ottemperano alla loro responsabilità per il riciclaggio, il trattamento, lo smaltimento ambientalmente compatibile sia direttamente sia partecipando ad un sistema collettivo.	Separate collection of waste electrical and electronic equipment. When this crossed-out wheeled bin symbol is attached to a product it means that the product is covered by the European Directive 2002/96/EC. This product must be disposed of separately from ordinary household wastes at its end of life. Disposal of the packaging and of the product should be done in accordance with local regulations. Please kindly be aware that it is your responsibility to dispose of electronic equipment at recycling centres to help conserve natural resources. Each country in the European Union should have its collection centres for electrical and electronic equipment recycling. For information about your recycling drop off point, please contact your local related electrical and electronic equipment waste management authority or the retailer where you bought the product. Correct disposal of your old product helps to prevent potential negative consequences for the environment and human health.	Dieses Symbol bedeutet, dass das Produkt aufgrund der bestehenden Vorschriften als Elektro- oder Elektronikgerät eingestuft ist und der EU-Richtlinie 2002/96/EG (WEEE) entspricht. Elektro- und Elektronikgeräte dürfen gemäß der EU-Richtlinie-WEEE nicht als unsortierter Siedlungsabfall beseitigt werden und gehören insbesondere nicht in den Hausmüll. Vielmehr sind diese Altgeräte getrennt zu sammeln und etwa über die örtlichen Sammel- und Rückgabesysteme zu entsorgen. Der Endverbraucher ist für die Übergabe des Altgerätes an eine geeignete Sammelstelle verantwortlich. Anderenfalls macht er sich aufgrund der geltenden Gesetze über die Müllentsorgung strafbar. Eine ordnungsgemäß getrennte Müllsammmlung der Altgeräte zu Recyclingzwecken und eine umweltgerechte Entsorgung vermeiden Umwelt- und Gesundheitsschäden, und ermöglichen die Wiederverwendung der Gerätebestandteile. Für weitere Informationen über die vorhandenen Sammelstellen wenden Sie sich bitte an Ihre Gemeinde oder an die Verkaufsstelle, wo Sie das Gerät gekauft haben. Die Hersteller und Importeure werden Ihre Verantwortung für das Produktrecycling und die umweltgerechte Entsorgung sowohl direkt als auch durch Teilnahme an einem Kollektivsystem gerecht.	Collecte sélective des appareils électriques et électroniques. L'utilisateur doit porter l'appareillage en fin de vie dans des centres de recyclage adaptés pour déchets électriques et électroniques, ou bien le livrer au revendeur au moment de l'achat d'un nouvel appareil de type équivalent. Le tri sélectif approprié pour le traitement successif et l'élimination compatible du dispositif avec l'environnement contribue à éviter des effets négatifs éventuels sur l'environnement et la santé, tout en favorisant la réutilisation et le recyclage des matériaux dont est composé l'appareillage. L'élimination abusive du produit par l'utilisateur comporte l'application de sanctions administratives, y-compris le décret législatif n. 22/1997.	Recogida selectiva de aparatos eléctricos y electrónicos. Al final de su vida, el producto tiene que ser llevado hasta centros de recogida selectiva para aparatos eléctricos y electrónicos o devuelto al fabricante, al adquirir de produco similares. El usuario es responsable de proporcionar el producto al final de su vida útil a las instalaciones de recogida apropiadas, bajo pena de las sanciones previstas por la legislación vigente sobre residuos. La recogida adecuada de residuos ispuesto para su reciclado, tratamiento y eliminación compatible con el medio ambiente, ayuda a evitar posibles efectos negativos sobre el medioambiente y la salud y favorece el reciclado de los materiales que componen el producto. Para obtener información más detallada sobre los sistemas de recolección disponibles, comuníquese con el servicio local de eliminación de desechos o la empresa donde se realizó la compra. Los fabricantes e importadores cumplen con su responsabilidad de reciclaje, tratamiento, eliminación compatible con el medio ambiente directamente o participando en un esquema colectivo.

Simboli Symbols	Prescrizioni	Prescriptions	Anforderungen	Prescriptions	Requisitos
	Prima di iniziare il montaggio, ad ogni controllo e manutenzione, disinserire la tensione di alimentazione agendo sull'interruttore generale dell'impianto elettrico.	Before starting the installation or any test and maintenance, shut the power off by switching off the main switch.	Bei Einbau-, Test- oder Wartungsarbeiten der Hauptschalter ausschalten.	Avant de commencer le montage ou à chaque contrôle et maintenance, couper la tension de l'alimentation, par l'interrupteur général de l'installation électrique.	Antes de empezar el ensamblaje, en cada control y mantenimiento, desconectar la fuente de alimentación, actuando en el interruptor principal del sistema eléctrico.
	Sostituire i vetri di protezione danneggiati	Replace the damaged protection glasses.	Die beschädigten Schutzgläser ersetzen.	Remplacer les verres de protection abimés	Reemplazar lo escudos protectores dañados
	Collegare l'apparecchio alla rete per mezzo di un interruttore magnetotermico adeguato.	Connect the fixture to the main through a suitable Magnetothermal switch	Die Leuchte an das Netz durch Magnetschutzhalter anschließen.	Brancher l'appareil au réseau à travers un interrupteur magnétothermique approprié.	Conectar el producto a la red eléctrica mediante un interruptor magnetotérmico apropiado.
	Gruppo rischio 1 L'apparecchio di illuminazione dovrebbe essere posizionato in modo che non sia prevista un'osservazione prolungata dell'apparecchio ad una distanza inferiore di 0.8 metri	RISK GROUP 1 The luminaire should be positioned so that prolonged staring at the luminaire at a distance closer than 0.8 m is not expected	RISIKO GRUPPE 1 Mit diesem Zeichen an der Leuchte wird der Sicherheitsabstand zwischen der Lichtquelle und dem Auge angegeben.	GRUPE DE RISQUE 1 Un appareil d'éclairage devrait être positionné pour faire en sorte qu'il ne soit pas prévue une observation prolongée de l'appareil à une distance inférieure de 0.8 mètres.	RIESGO GRUPO 1 El producto de iluminación debería que ser posicionado en la manera que no sea planeada una observación prolongada a una distancia menor que 0.8m
	Il prodotto non è soggetto a manutenzione da parte dell'utilizzatore. Può essere solo sostituito. La sorgente luminosa contenuta in questo apparecchio deve essere sostituita solo dal costruttore.	The fixture does not require any maintenance from the user. It can only be replaced. The light source inside the fitting must be replaced by the manufacturer only.	Die Leuchte kann nur ersetzt sein. Keine Wartungsarbeit ist vorgesehen. Das LED Modul darf nur vom Hersteller ausgetauscht sein.	L'appareil ne demande aucune maintenance de la part de l'utilisateur. Il peut seulement remplacer le produit. La source lumineuse montée dans l'appareil doit être remplacé exclusivement par le fabricant.	El product no está sujeto a mantenimiento por el usuario. Puede ser sólo reemplazado. La fuente de luz contenida en este aparato debe ser reemplazada sólo por el fabricante.

1.3 Accessori

Accessories

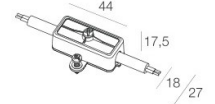
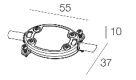
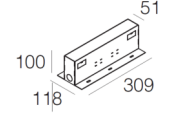
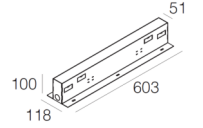
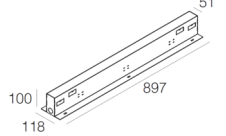
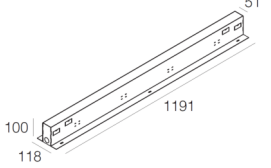
Codice prodotto Reference number	Descrizione Description	Dimensioni Dimensions
A00357.40	Micro Connettore Stagno Microwatertight connector	
A00519.60	Connettore stagno Watertight connector	
A01209.60 – 24Vdc	Controcasse Recessed boxes	
A01213.60 – 220-240 Vac		
A01210.60 – 24Vdc	Controcasse Recessed boxes	
A01214.60 – 220-240 Vac		
A01211.60 – 24Vdc	Controcasse Recessed boxes	
A01215.60 – 220-240 Vac		
A01212.60 – 24Vdc	Controcasse Recessed boxes	
A01216.60 – 220-240 Vac		

2 INSTALLAZIONE

INSTALLATION - INSTALLATION - INSTALLATION - INSTALACIÓN

2.1 Cablaggio elettrico

Electrical wiring - Câblage - Elektrische Verdrahtung - Cableado eléctrico

NOTA	NOTE	NOTE	ANMERKUNG	NOTA
Questo apparecchio è garantito solo se utilizzato con alimentatori DGA in bassa tensione a corrente costante.	This fixture is guaranteed only if installed with constant current DGA drivers	Cet appareil est garanti uniquement s'il est utilisé avec les alimentations DGA, à courant constant	Für dieses Produkt wird nur garantiert, wenn DGA Betriebsgeräte mit Konstantstrom verwendet werden.	Este aparato se garantiza en caso de utilizarlo exclusivamente con alimentadores DGA en baja tensión y corriente constante
ATTENZIONE	CAUTION	ATTENTION	ACHTUNG	CUIDADO
Non collegare o scollegare MAI l'apparecchio con l'alimentatore sotto tensione.	NEVER connect or disconnect the fixture when the driver is energized	Ne jamais brancher ou débrancher l'appareil quand l'alimentation est sous tension	Bitte nie eine Komponente abmontieren oder neu anschließen, wenn das Betriebsgerät unter Strom steht.	Nunca enchufe o desenchufe el aparato con el alimentador funcionando

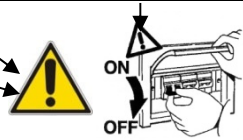

ISTRUZIONI	INSTRUCTIONS	INSTRUCTIONS	ANWEISUNG	INSTRUCCIONES
A) Eseguire il cablaggio in assenza di tensione di rete B) Collegare l'apparecchio all'alimentatore C) Collegare l'alimentatore alla rete D) Porre la rete sotto tensione	A) Make the wiring in complete absence of line voltage B) Connect the fixture to the driver C) Connect the driver to the electric network D) Energize the network	A) Effectuer le câblage en absence de tension du réseau B) Brancher l'appareil à l'alimentation C) Brancher l'alimentation au réseau D) Alimenter le réseau	A) Verdrahten Sie das Produkt nur in Abwesenheit von Netzspannung. B) Verdrahten Sie das Produkt an das Betriebsgerät. C) Verdrahten Sie das Produkt mit dem Betriebsgerät. D) Aktivieren Sie das Stromnetz.	A) Cablear en ausencia de tensión B) Enchufar el aparato con el alimentador. C) Enchufar el alimentador con la red D) Ponere la red en tensión.

2.2 Collegamenti

Connection - Connexion - Verdrahtung - Conexión

Per n. LEDs collegabili vedi manuale alimentatore.

N. of LEDs to connect: see driver manual. - Voir notice de l'alimentation pour savoir combien de LEDs brancher. - Bitte lesen Sie die Bedienungsanleitung des Betriebsgerätes bezüglich der Anzahl der verdrahtbaren LEDs. - Para saber cuántos LEDs conectar véase el manual del alimentador.

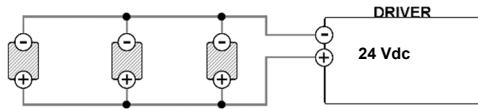

ATTENZIONE: Alimentatori SELV consigliati per il collegamento

Driver	30 W/m	30 W/m DYNAMIC WHITE
CV70-F-24-P	1,2 m	
CV100-L-24-NL		1,2

INDICAZIONI DI CABLAGGIO



Red / Rosso Positive / Positivo
Nero / black Negative / Negativo

RISPETTARE LA POLARITA'

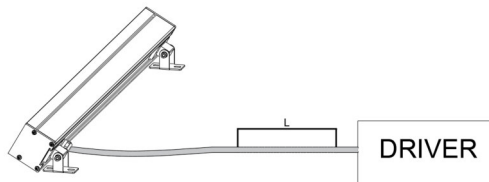

L (m) - Lunghezza max - max length

10 m

S (mm²) - Sezione Cavo - Cable section

1 mm

2.3 Montaggio meccanico

Mechanical Mounting - Montage mécanique - Einbau - Montaje mecánico

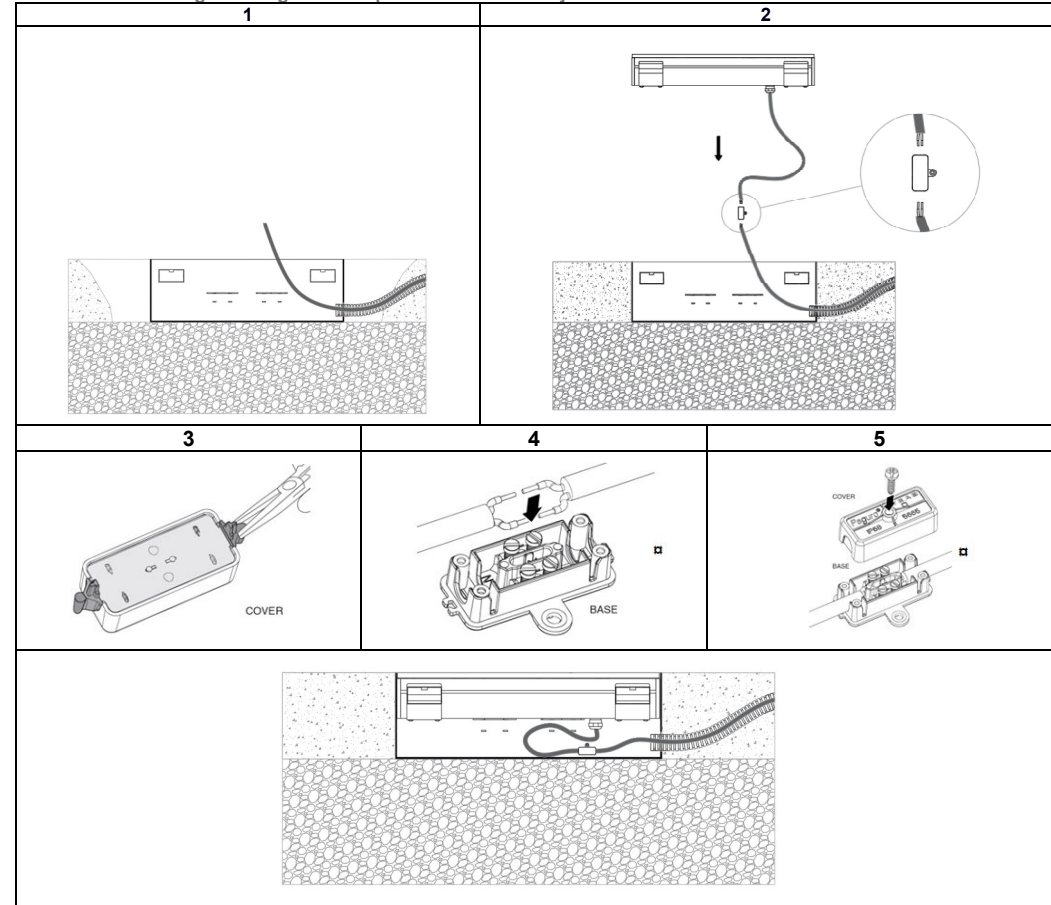

2.4 Simboli e prescrizioni

Symbols and prescriptions

Simboli Symbols	Prescrizioni	Prescriptions	Anforderungen	Prescriptions	Requisitos
	Attesta la conformità del prodotto alle disposizioni delle direttive Comunitarie.	The product is in compliance with the essential requirements and relevant EU Product Directives.	Das Produkt genügt den geltenden Anforderungen, die in den Harmonisierungsvorschriften der Europäischen Union, die ihre Anbringung vorschreiben, festgelegt sind.	L'appareil est conforme aux principes essentiels et aux relative directive de l'Union Européenne	Certifica la conformidad del product con las disposiciones de las directivas Comunitarias
	Attenzione, rischio di scossa elettrica. Il collegamento elettrico deve essere eseguito solo da personale tecnico competente	Caution, risk of electrical shock. Electric connection has to be carried out by technically competent personnel only.	Achtung: Gefahr von Stromschlag. Die elektrische Verbindung darf nur von qualifiziertem Personal durchgeführt sein.	Attention, risque de choc électrique. La connexion électrique doit être effectuée uniquement par techniciens compétents.	Atención! Riesgo de descarga eléctrica. El collegamento eléctrico tiene que ser realizado solo por personal técnico competente