

DGA

MICRO

















-  IP67
-  Class III 350mA
-  Montaggio a parete, soffitto, pavimento
Wall, ceiling, floor mounting
-  WIPS - Water Infiltration Protection System
-  Cavo in neoprene 200 cm
200 cm neoprene cable
(disponibile lunghezza cavo su misura)
(additional cable length available upon request)
-  Collegare in serie 350mA
Connect in series at 350mA
-  160 gr
-  Altamente riciclabile
Highly recyclable



Tre sistemi di fissaggio
Alte prestazioni
Totale integrazione
all'ambiente

Three fastening systems
High performance
Total integration with the
environment





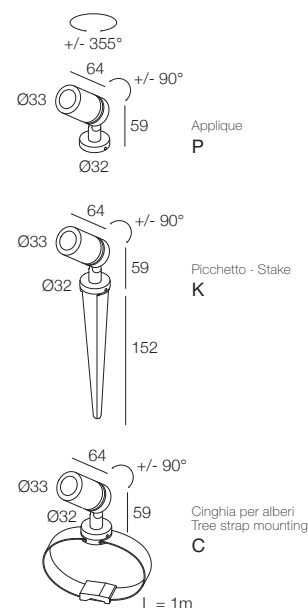











MICRO

	3W 350mA	Finiture Finish	Colore LED LED Colour	Elementi di fissaggio Fixing element
Lumen Output 3000K	270lm			
 15° Lens	7A0833.____-UL	 3 Grigio - Gray  4 Nero - Black  E Ottone Integrale Massive Brass	 U 2200K  Y 2700K  W 3000K CRI > 90  6 3000K  9 4000K	 P Applique - Applique  K Picchetto - Stake  C Cinghia per alberi Tree strap mounting
 30° Lens	760833.____-UL			
 60° Lens	750833.____-UL			
 Vetro satinato Frosted glass	710832.____-UL			
 Lente ellittica Elliptical lens	770833.____-UL			



MICRO

CON NIDO D'APE - WITH HEX LOUVER

	3W 350mA	Finiture Finish	Colore LED LED Colour	Elementi di fissaggio Fixing element
Lumen Output 3000K	270lm			
 15° Lens	7A4151.____-UL	 3 Grigio - Gray  4 Nero - Black  E Ottone Integrale Massive Brass	 U 2200K  Y 2700K  W 3000K CRI > 90  6 3000K  9 4000K	 P Applique - Applique  K Picchetto - Stake  C Cinghia per alberi Tree strap mounting
 30° Lens	764151.____-UL			
 60° Lens	754151.____-UL			
 Vetro satinato Frosted glass	714151.____-UL			
 Lente ellittica Elliptical lens	774151.____-UL			

ALIMENTATORI CONSIGLIATI (non inclusi)
SUGGESTED DRIVERS (not included)

350mA CC30-M-350-NW

ACCESSORI
ACCESSORIES



Visiera
antiabbagliamento
Low glare visor
A00846._0

Visiera cilindrica
antiabbagliamento
Low glare snoot
A00847._0

EXAMPLE CODE COMPOSITION
123456.____-UL

