

Ariel PN-m Plug&play

Projectors | IP40 | Class III | Dimmable

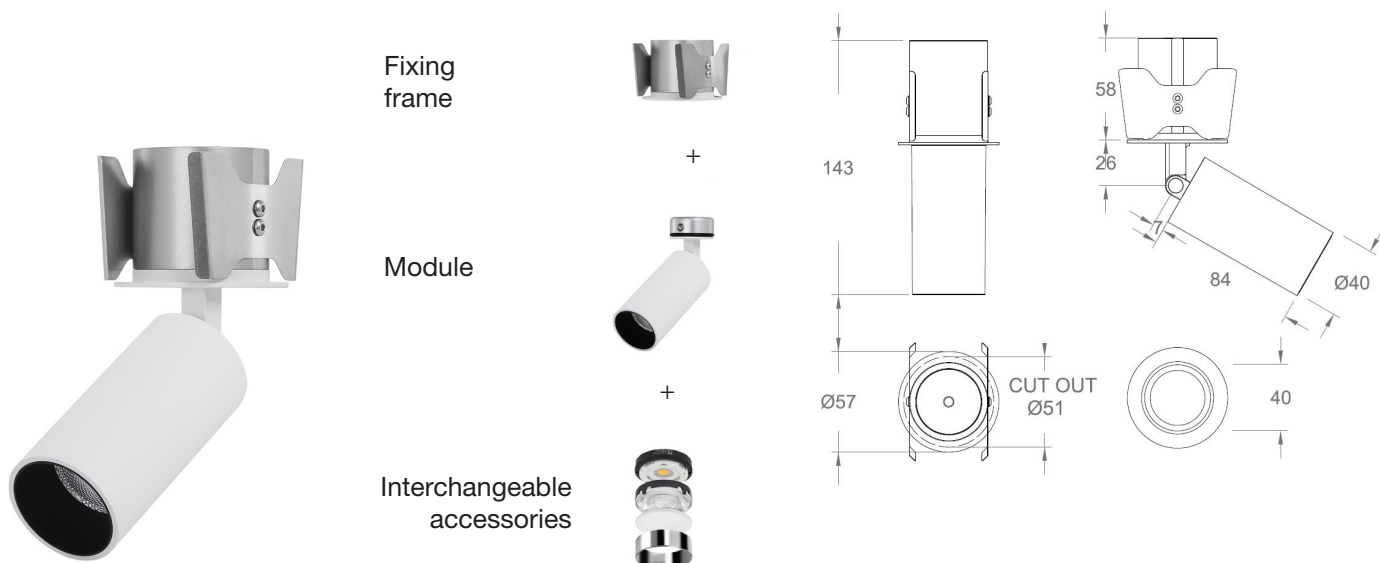

LIGHT SOURCE & OPTIC

Power

9W
11W

Lens

14° - not interchangeable
18° / 24° / 33° / 52° - interchangeable

Beam Direction

Adjustable:
Tilting +/-90°, rotating +/-355°,
Symmetrical

Material

PMMA

LED quantity

1

Binning

2 MacAdam steps

Color temperature & quality

2200K CRI>90
2400K CRI>90
2700K CRI>90/95
3000K CRI>80/90/95
3500K CRI>90/95
4000K CRI>90

Lifetime

(L70) >77.000 hrs

FIXTURE

Dimensions

Ø 40mm x H 84mm (cylinder)

Material

Aluminium

Module finishes

Warm White (RAL 9010)
White (RAL 9003)
Gray White (RAL 9002)
Gothic Cement (RAL 7033)
Gray (RAL 7012)
Beige Gray (RAL 7006)
Brown (RAL 8019)
Black (RAL 9005)

Filter holder finishes

Gold Chrome
Shiny Chrome
Satin Gold
Satin Nickel
Black

Weight

330gr

Mounting

Semirecessed: cut out Ø 51mm

Fixing

Fixing frame with springs

Working temperature

-20° / +40°

ELECTRICAL FEATURES

Power supply

Constant current:
500 mA
700mA
Typical Vf= 18V

Driver requirement

Remote (not included)

Control

On/off
Push switch
Phase Cut
0/1-10 V
Casambi
DALI

Ariel PN-m Plug&play

PHOTOMETRIC DATA (3000K CRI>90)

9W - 18° | UGR 12

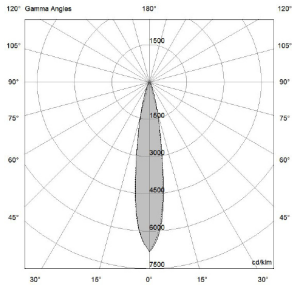

H (m)	D (m)	Eav (lx)
1	0.32	3087
2	0.64	772
3	0.96	343
4	1.28	193
5	1.60	123

Total lumen output
712 lm

Efficacy
79 lm/W

9W - 24° | UGR 14

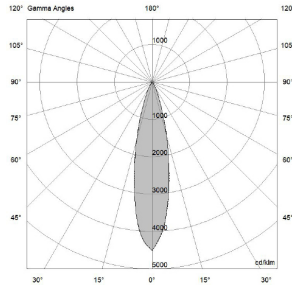

H (m)	D (m)	Eav (lx)
1	0.42	1919
2	0.83	480
3	1.25	213
4	1.67	120
5	2.08	77

Total lumen output
703 lm

Efficacy
78 lm/W

9W - 33° | UGR 16

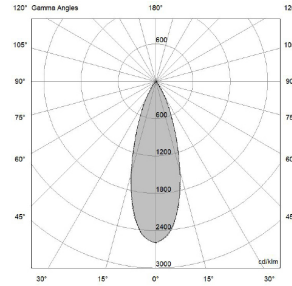

H (m)	D (m)	Eav (lx)
1	0.60	980
2	1.21	245
3	1.81	109
4	2.41	61
5	3.02	39

Total lumen output
618 lm

Efficacy
69 lm/W

9W - 52° | UGR 20

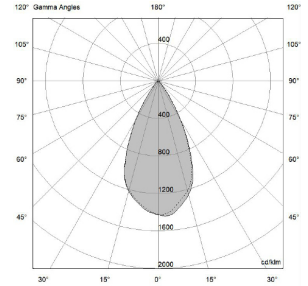

H (m)	D (m)	Eav (lx)
1	0.69	550
2	1.93	138
3	2.89	61
4	3.85	34
5	4.82	22

Total lumen output
683 lm

Efficacy
76 lm/W

9W - 14° | UGR 9

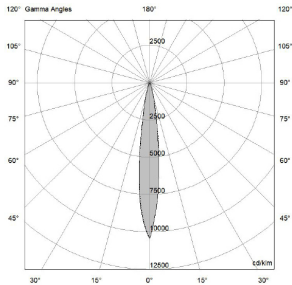

H (m)	D (m)	Eav (lx)
1	0.25	4298
2	0.50	1074
3	0.76	478
4	1.01	269
5	1.26	172

Total lumen output
659 lm

Efficacy
73 lm/W

Ariel PN-m Plug&play

PHOTOMETRIC DATA (3000K CRI>90)

11W - 18° | UGR 13

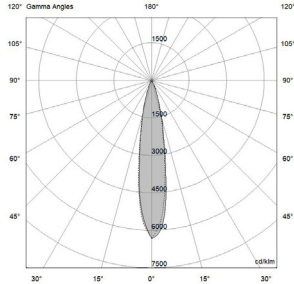

H (m)	D (m)	Eav (lx)
1	0.33	3452
2	0.65	863
3	0.98	384
4	1.31	216
5	1.63	138

Total lumen output
857 lm

Efficacy
78 lm/W

11W - 24° | UGR 15

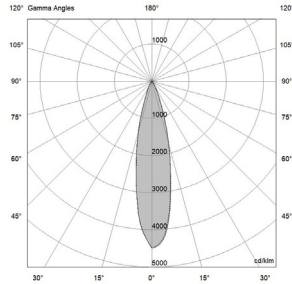

H (m)	D (m)	Eav (lx)
1	0.42	2318
2	0.83	579
3	1.25	258
4	1.67	145
5	2.09	93

Total lumen output
824 lm

Efficacy
75 lm/W

11W - 33° | UGR 17

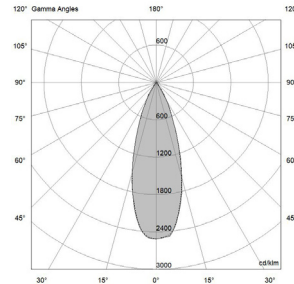

H (m)	D (m)	Eav (lx)
1	0.63	1150
2	1.26	287
3	1.89	128
4	2.52	72
5	3.15	46

Total lumen output
750 lm

Efficacy
68 lm/W

11W - 52° | UGR 21

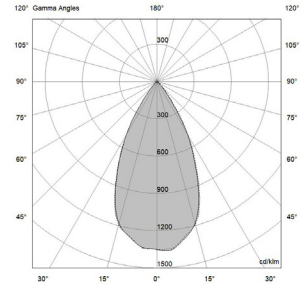

H (m)	D (m)	Eav (lx)
1	0.97	624
2	1.94	156
3	2.91	69
4	3.88	39
5	4.85	25

Total lumen output
809 lm

Efficacy
74 lm/W

11W - 14° | UGR 10

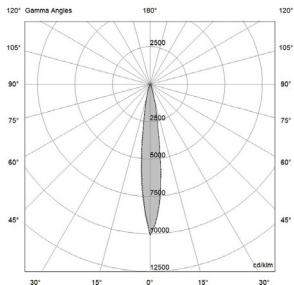

H (m)	D (m)	Eav (lx)
1	0.25	4734
2	0.51	1183
3	0.76	526
4	1.02	296
5	1.27	189

Total lumen output
752 lm

Efficacy
86 lm/W

Ariel PN-m Plug&play

INTERCHANGEABLE ACCESSORIES

Plug&Play Modules (CCT)

For 14° lens:

2200K CRI>90
 2400K CRI>90
 2700K CRI>90/95
 3000K CRI>80/90/95
 3500K CRI>90/95
 4000K CRI>90

For 18° / 24° / 33° / 52° lens:

2200K CRI>90
 2400K CRI>90
 2700K CRI>90/95
 3000K CRI>80/90/95
 3500K CRI>90/95
 4000K CRI>90

Optical Filters

Hex louver
 Elliptical Filter
 Prismatic filter
 Softening lens

Lenses

18° / 24° / 33° / 52°

INSTALLATION ACCESSORIES

Fixing rame (A01727._0)

Necessary element: please specify always 1 frame for each Fixture in the purchase order

SUGGESTED REMOTE DRIVERS

On/Off :

CC20-F-500-N

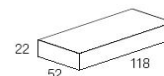

Ø 55

CC23-F-700-SP

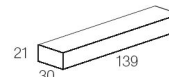

Ø 37

Multifunction (DALI 2, 0/1-10V, PUSH RIPPLE FREE, AM DIMMING):

CC25-DM-500-N

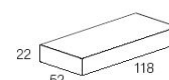

Ø 55

CC15-D-700-S

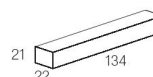

Ø 30

Other options upon request