

# Ariel i IP67

Recessed Light | IP67 | Class III | Dimmable

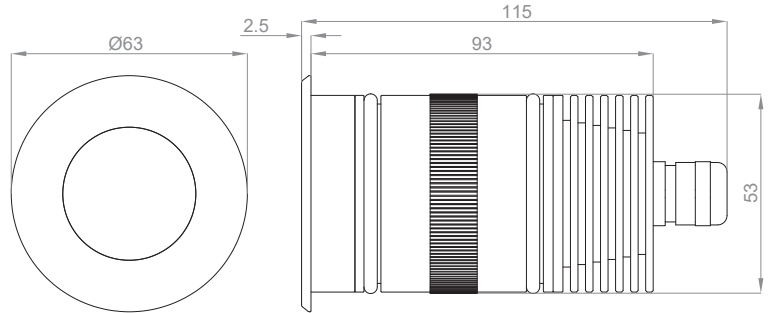

## LIGHT SOURCE & OPTIC

### Power

9W  
9.5W

### Lens

14° / 18° / 24° / 33° / 52°

### Beam Direction

Fixed

### Material

PMMA

### LED quantity

1

### Binning

2 MacAdam steps

### Color temperature & quality

2200K CRI>90  
2400K CRI>90  
2700K CRI>90  
3000K  
3000K CRI>90  
3500K CRI>90  
4000K CRI>90

### Lifetime

(L90) >55.000 hrs

## FIXTURE

### Dimensions

Ø 63mm x H 115mm

### Material

Aluminium

### Body finishes

Black  
Grey  
Stainless Steel AISI 316L

### Weight

400gr

### Mounting

Recessed

### Fixing

Wall - Floor Recessed

### Working temperature

-20° / +40°

## ELECTRICAL FEATURES

### Power supply

Main Voltage:  
24 Vdc  
500 mA

### Driver requirement

Remote (not included)

### Control

On/off  
Push switch  
Phase Cut  
0/1-10 V  
Casambi  
DALI

# Ariel i IP67

## PHOTOMETRIC DATA (3000K CRI>90)

**9W - 14° | UGR 4.1**

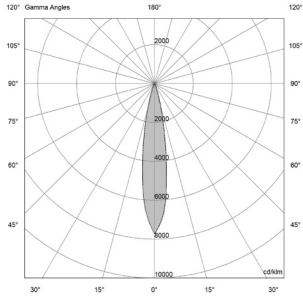

H (m)	D (m)	Eav (lx)
1	0.32	4574
2	0.64	1144
3	0.95	508
4	1.27	286
5	1.59	183

**Total lumen output**  
592 lm

**Efficacy**  
69 lm/W

**9W - 18° | UGR 6.4**

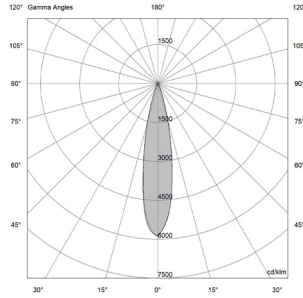

H (m)	D (m)	Eav (lx)
1	0.37	3793
2	0.75	948
3	1.12	421
4	1.50	237
5	1.87	152

**Total lumen output**  
644 lm

**Efficacy**  
74 lm/W

**9W - 24° | UGR 8.7**

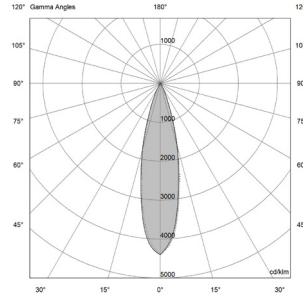

H (m)	D (m)	Eav (lx)
1	0.44	2793
2	0.89	68
3	1.33	310
4	1.78	175
5	2.22	112

**Total lumen output**  
635 lm

**Efficacy**  
72 lm/W

**9W - 33° | UGR 12.4**

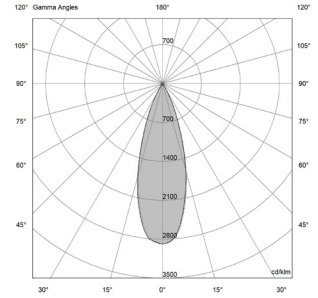

H (m)	D (m)	Eav (lx)
1	0.60	1595
2	1.19	399
3	1.79	177
4	2.39	100
5	2.98	64

**Total lumen output**  
552 lm

**Efficacy**  
62 lm/W

**9W - 52° | UGR 18.9**

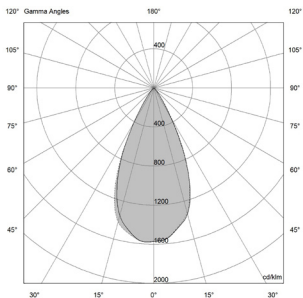

H (m)	D (m)	Eav (lx)
1	0.91	979
2	1.82	245
3	2.73	109
4	3.65	61
5	4.56	39

**Total lumen output**  
619 lm

**Efficacy**  
69 lm/W

# Ariel i IP67

## PHOTOMETRIC DATA (3000K CRI>90) - Elliptical filter

**9W - 14° | UGR 8.5**

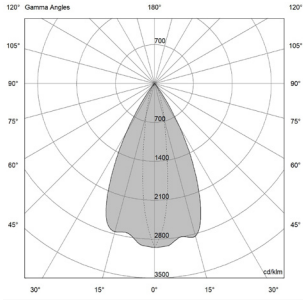

H (m)	D (m)	Eav (lx)
1	1.01	1228
2	2.02	307
3	3.02	136
4	4.03	77
5	5.04	49

**Total lumen output**  
416 lm

**Efficacy**  
47 lm/W

**9W - 18° | UGR 9.5**

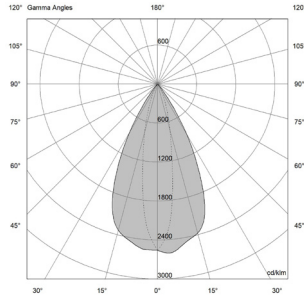

H (m)	D (m)	Eav (lx)
1	0.35	1311
2	0.71	328
3	1.06	146
4	1.42	82
5	1.77	52

**Total lumen output**  
506 lm

**Efficacy**  
57 lm/W

**9W - 24° | UGR 8.9**

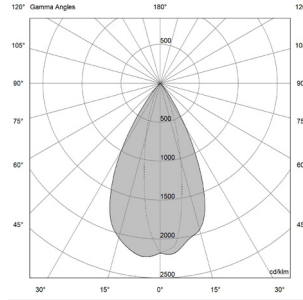

H (m)	D (m)	Eav (lx)
1	1.03	1122
2	2.05	280
3	3.08	125
4	4.10	70
5	5.13	45

**Total lumen output**  
499 lm

**Efficacy**  
56 lm/W

**9W - 33° | UGR 13.6**

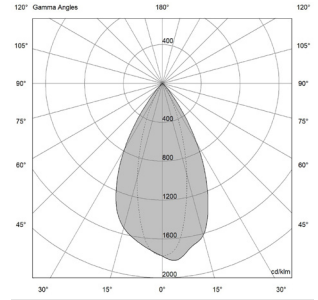

H (m)	D (m)	Eav (lx)
1	1.05	773
2	2.09	193
3	3.14	86
4	4.18	48
5	5.23	31

**Total lumen output**  
426 lm

**Efficacy**  
60 lm/W

**9W - 52° | UGR 18.3**

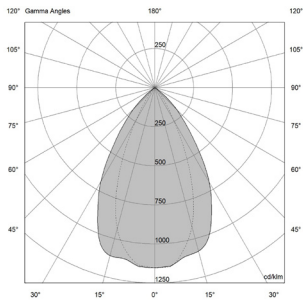

H (m)	D (m)	Eav (lx)
1	1.29	558
2	2.59	139
3	3.88	62
4	5.18	35
5	6.47	22

**Total lumen output**  
484 lm

**Efficacy**  
54 lm/W

# Ariel i IP67

## PHOTOMETRIC DATA (3000K CRI>90) - Hex louver

**9W - 14° | UGR 6.1**

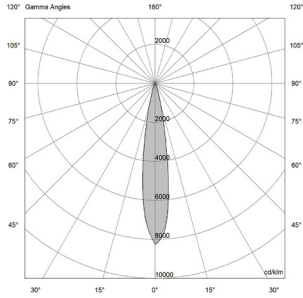

H (m)	D (m)	Eav (lx)
1	0.31	3602
2	0.61	900
3	0.92	400
4	1.23	225
5	1.53	144

**Total lumen output**  
436 lm

**Efficacy**  
50 lm/W

**9W - 18° | UGR 4.2**

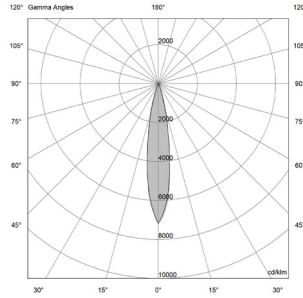

H (m)	D (m)	Eav (lx)
1	0.32	3470
2	0.63	867
3	0.95	386
4	1.27	217
5	1.59	139

**Total lumen output**  
482 lm

**Efficacy**  
56 lm/W

**9W - 24° | UGR 6**

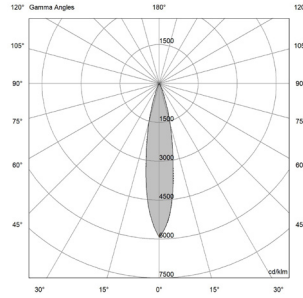

H (m)	D (m)	Eav (lx)
1	0.35	2711
2	0.71	678
3	1.06	301
4	1.41	169
5	1.77	108

**Total lumen output**  
456 lm

**Efficacy**  
52 lm/W

**9W - 33° | UGR 8.4**

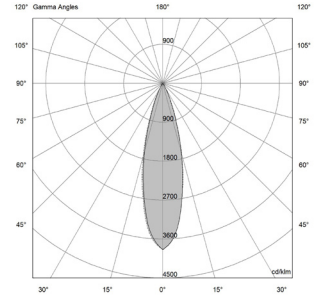

H (m)	D (m)	Eav (lx)
1	0.48	1474
2	0.96	369
3	1.43	164
4	1.91	92
5	2.39	59

**Total lumen output**  
383 lm

**Efficacy**  
43 lm/W

**9W - 52° | UGR 13**

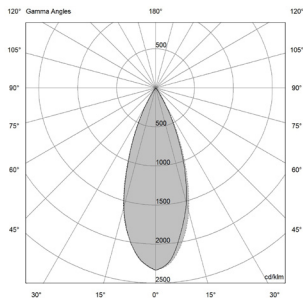

H (m)	D (m)	Eav (lx)
1	0.69	860
2	1.37	215
3	2.06	96
4	2.75	54
5	3.43	34

**Total lumen output**  
368 lm

**Efficacy**  
41 lm/W

# Ariel i IP67

## PHOTOMETRIC DATA (3000K CRI>90) - Prismatic filter

**9W - 14° | UGR 13.8**

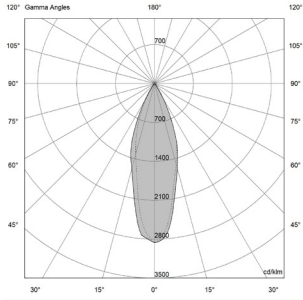

H (m)	D (m)	Eav (lx)
1	0.61	1214
2	1.23	303
3	1.84	135
4	2.46	76
5	3.07	49

**Total lumen output**  
424 lm

**Efficacy**  
48 lm/W

**9W - 18° | UGR 15.6**

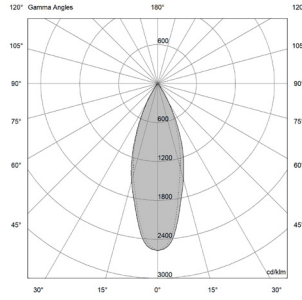

H (m)	D (m)	Eav (lx)
1	0.66	1310
2	1.31	328
3	1.97	146
4	2.63	82
5	3.28	52

**Total lumen output**  
5.9 lm

**Efficacy**  
57 lm/W

**9W - 24° | UGR 16**

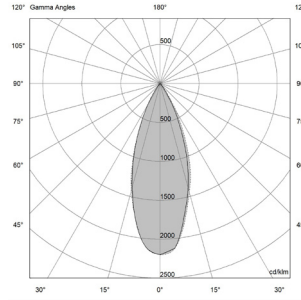

H (m)	D (m)	Eav (lx)
1	0.67	1103
2	1.35	276
3	2.02	123
4	2.69	69
5	3.37	44

**Total lumen output**  
502 lm

**Efficacy**  
56 lm/W

**9W - 33° | UGR 17.8**

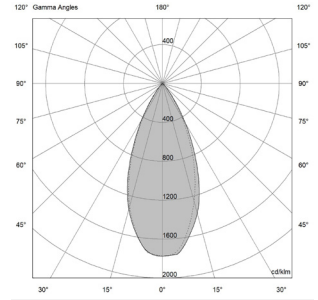

H (m)	D (m)	Eav (lx)
1	0.84	772
2	1.68	193
3	2.52	86
4	3.36	48
5	4.20	31

**Total lumen output**  
435 lm

**Efficacy**  
49 lm/W

**9W - 52° | UGR 22.2**

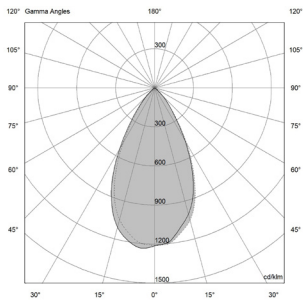

H (m)	D (m)	Eav (lx)
1	1.04	606
2	2.07	152
3	3.11	67
4	4.14	38
5	5.18	24

**Total lumen output**  
493 lm

**Efficacy**  
55 lm/W

# Ariel i IP67

## PHOTOMETRIC DATA (3000K CRI>90) - Softening filter

**9W - 14° | UGR 7.8**

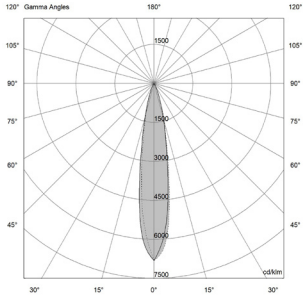

H (m)	D (m)	Eav (lx)
1	0.32	3481
2	0.64	870
3	0.95	387
4	1.27	218
5	1.59	139

**Total lumen output**  
510 lm

**Efficacy**  
59 lm/W

**9W - 18° | UGR 9.6**

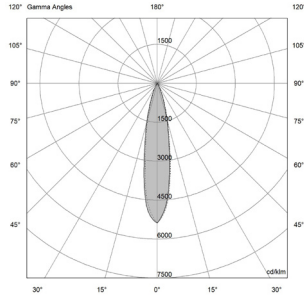

H (m)	D (m)	Eav (lx)
1	0.36	3320
2	0.72	830
3	1.09	369
4	1.45	208
5	1.81	133

**Total lumen output**  
617 lm

**Efficacy**  
70 lm/W

**9W - 24° | UGR 11.8**

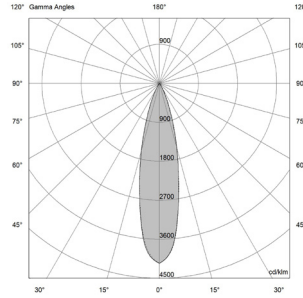

H (m)	D (m)	Eav (lx)
1	0.44	1565
2	0.87	391
3	1.31	174
4	1.75	156
5	2.18	100

**Total lumen output**  
602 lm

**Efficacy**  
68 lm/W

**9W - 33° | UGR 14.1**

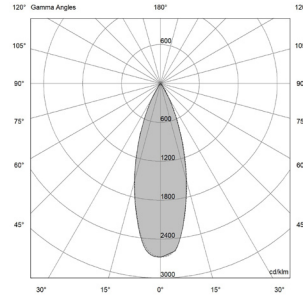

H (m)	D (m)	Eav (lx)
1	0.61	1389
2	1.21	347
3	1.82	154
4	2.42	87
5	3.03	56

**Total lumen output**  
519 lm

**Efficacy**  
58 lm/W

**9W - 52° | UGR 19.4**

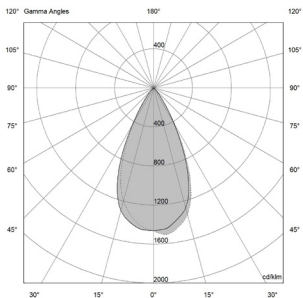

H (m)	D (m)	Eav (lx)
1	0.95	858
2	1.90	214
3	2.85	95
4	3.80	54
5	4.75	34

**Total lumen output**  
575 lm

**Efficacy**  
64 lm/W

# Ariel i IP67

## INSTALLATION ACCESSORIES

Aluminium recessed box (A01416.40)

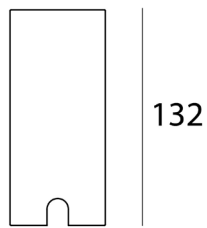

Ø58 

Watertight connector (A00387.40)

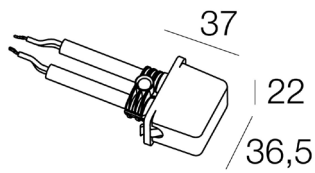

## SUGGESTED REMOTE DRIVER

### On/off:

CC14-F-500-PI / CV30-F-24-PI

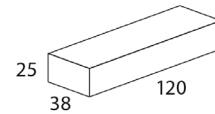

 Ø 44

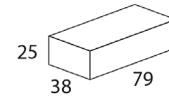

 Ø 44

### Multifunction (DALI 2, 0/1-10V, PUSH):

CC20-M-500-P / CV25-D-24-PI

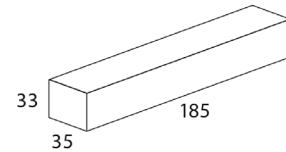

 Ø 66

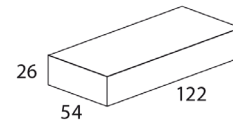

 Ø 60